

着物型

衿

5cm巾

着物型

衿

5cm巾

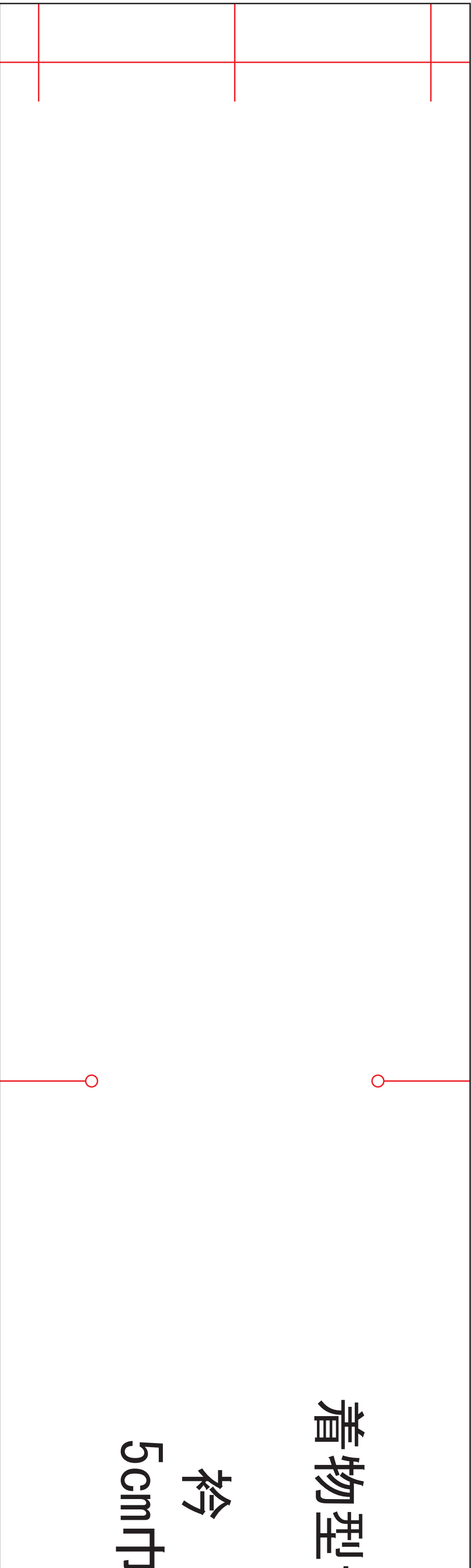

着

袖付側

物型サンプル袖

各2枚

ゆき47

袖
口
側



着物

袖付止

N.P

G.B

N.P

サンプル

各1枚



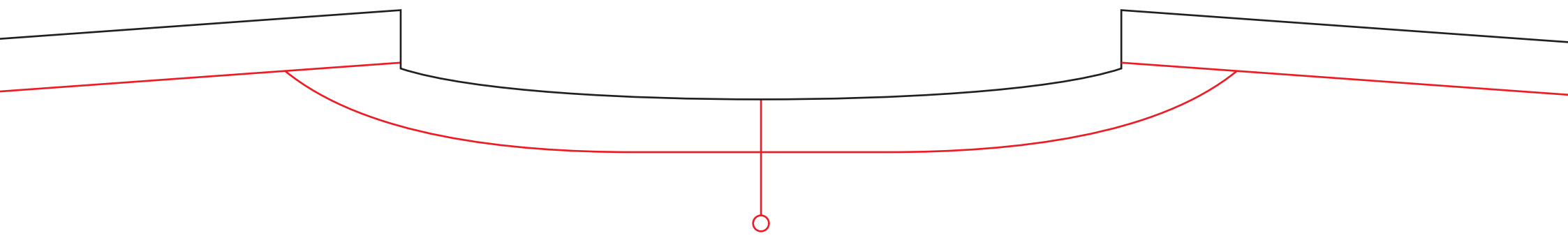

物型サンプル

後
各1枚

C
・
B

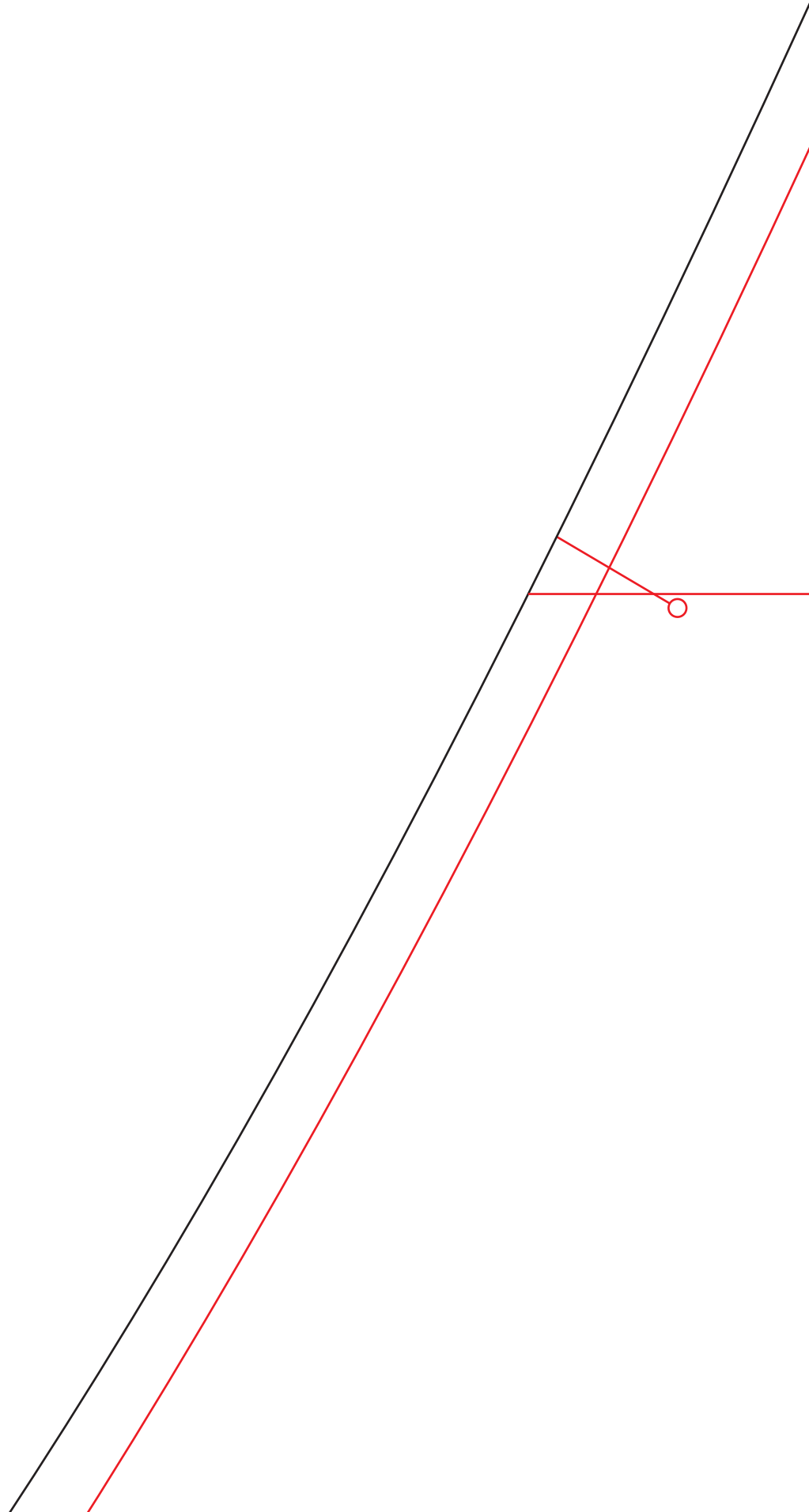
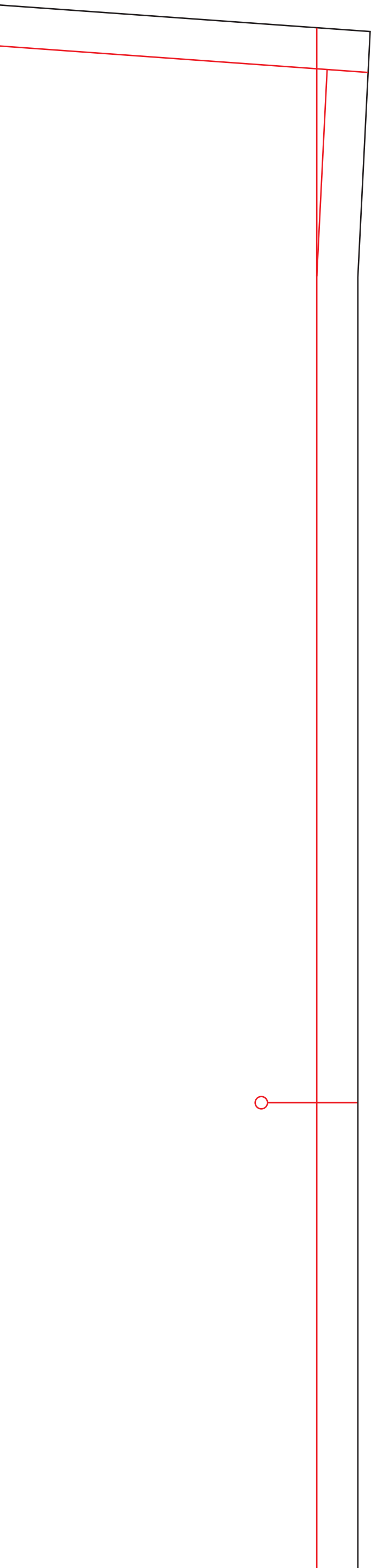

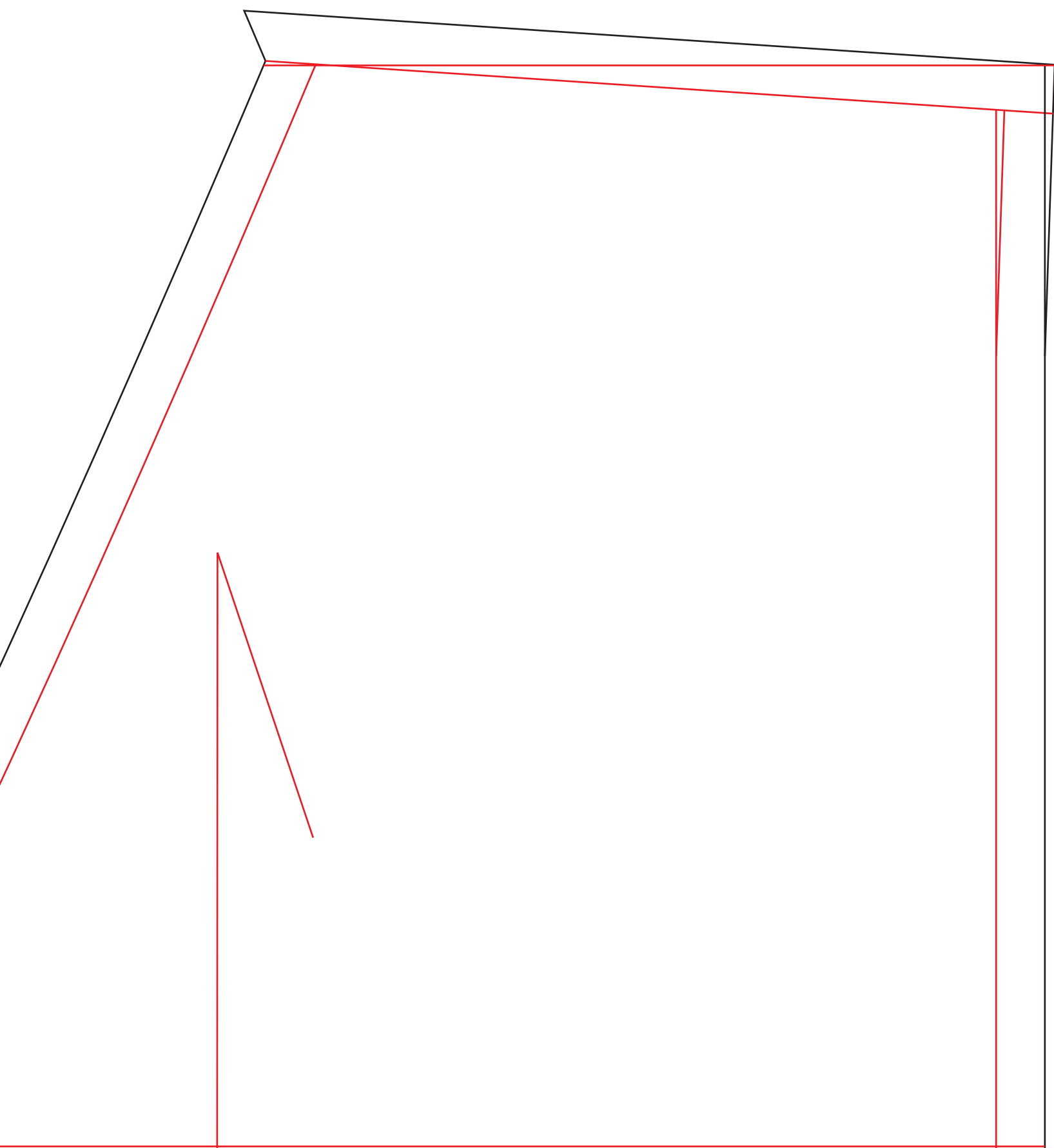

着物型サンプル

袖止

前
各2枚

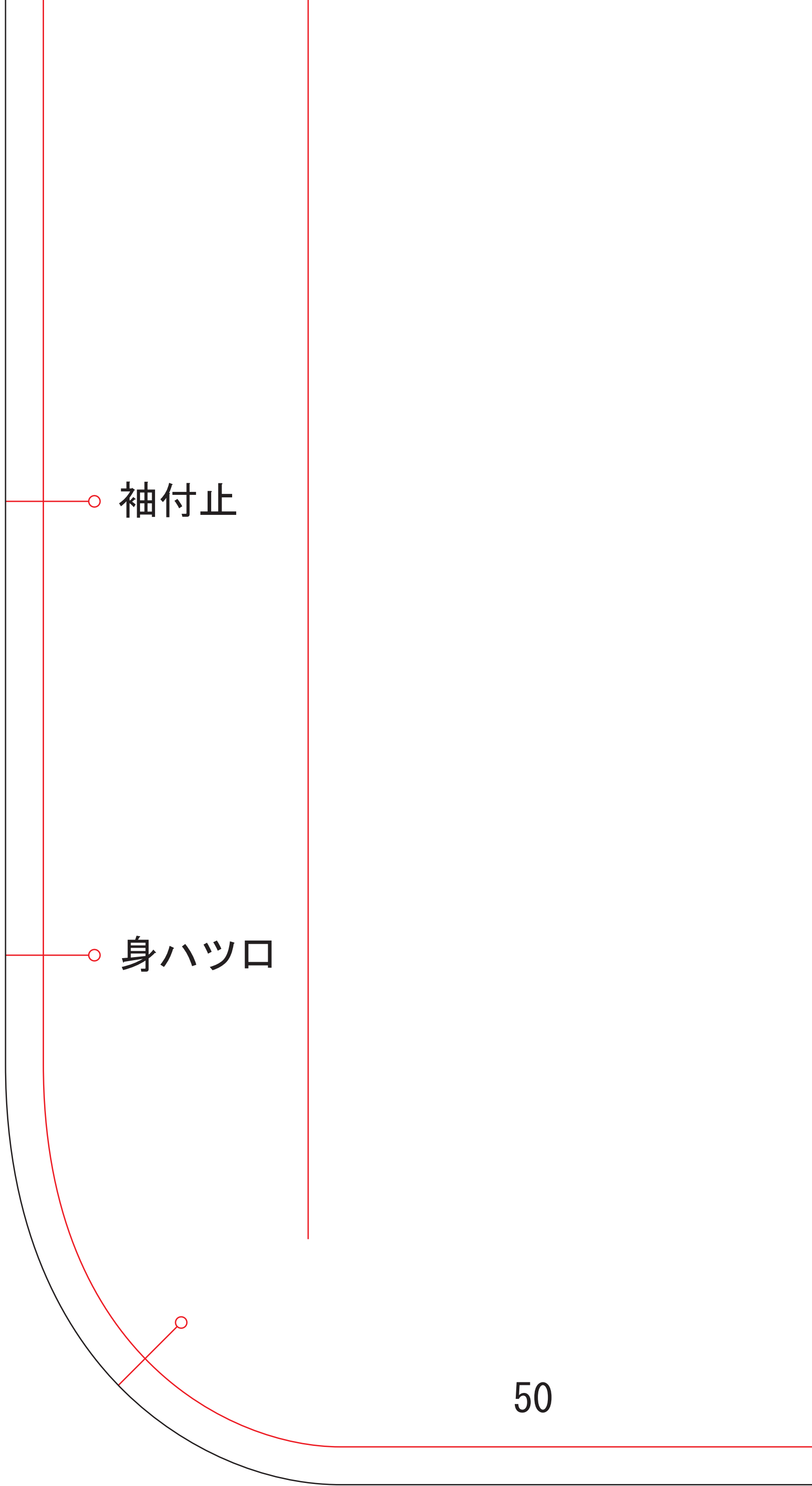

袖付止

身ハツロ

50

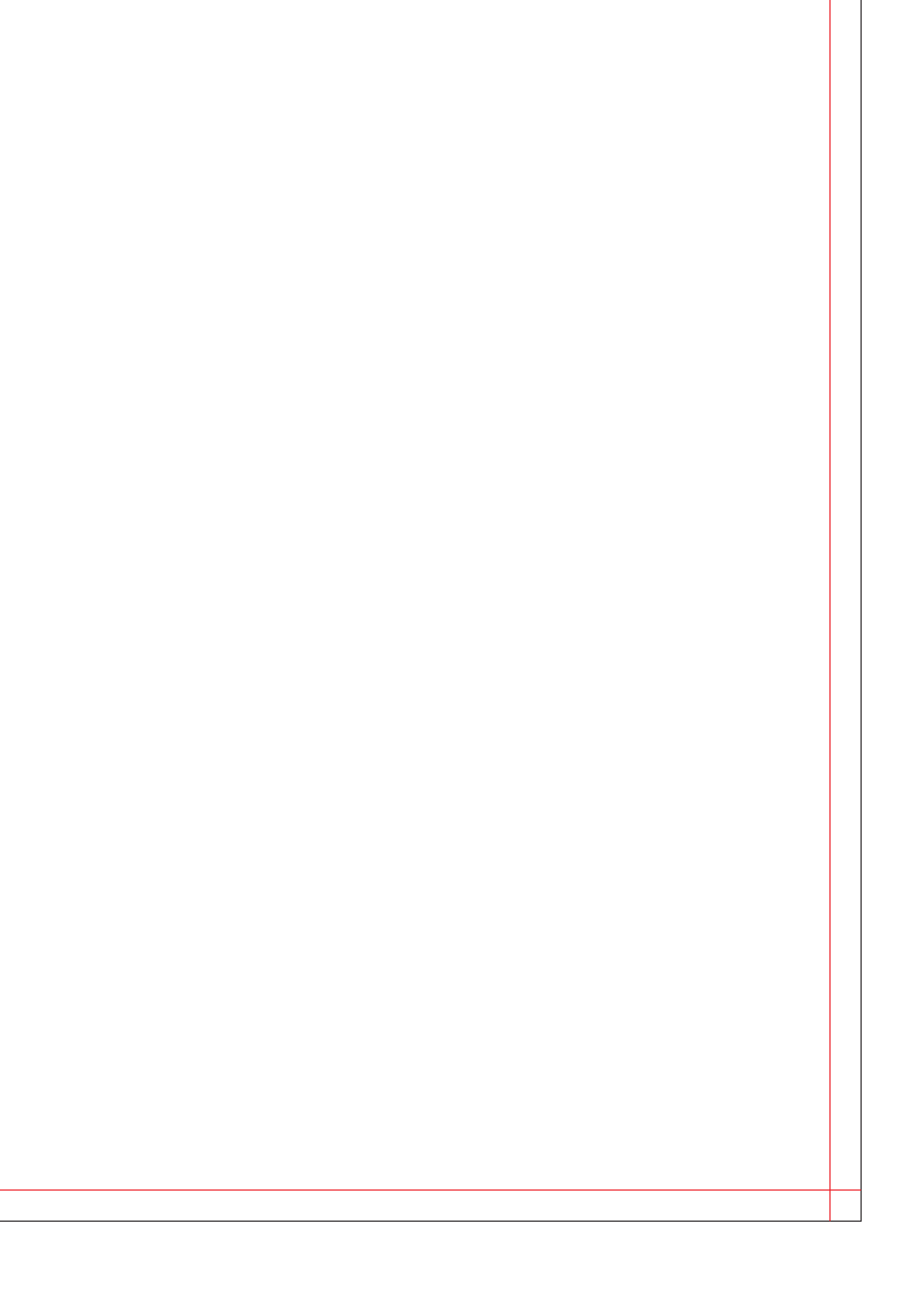

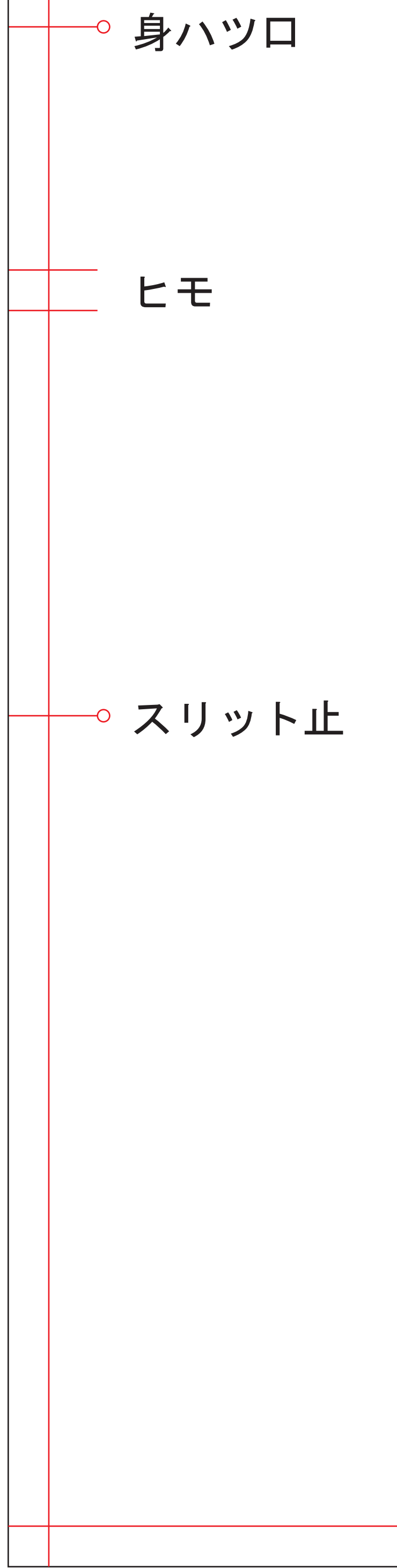
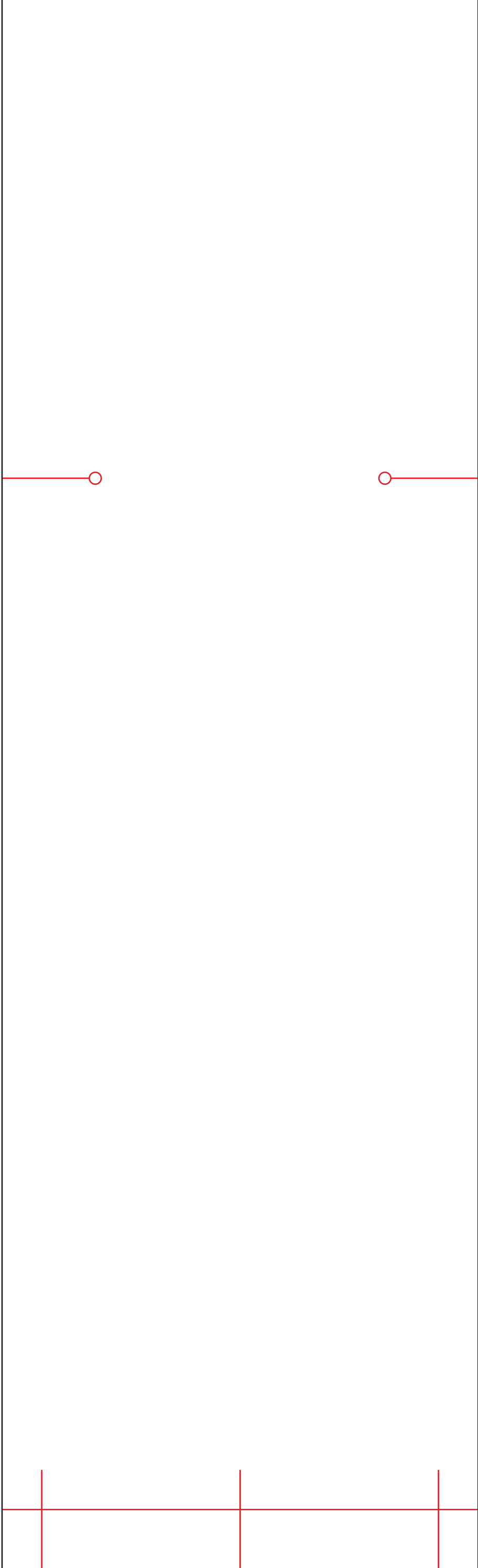



丈75

ヒモ

ヒモ

F・C

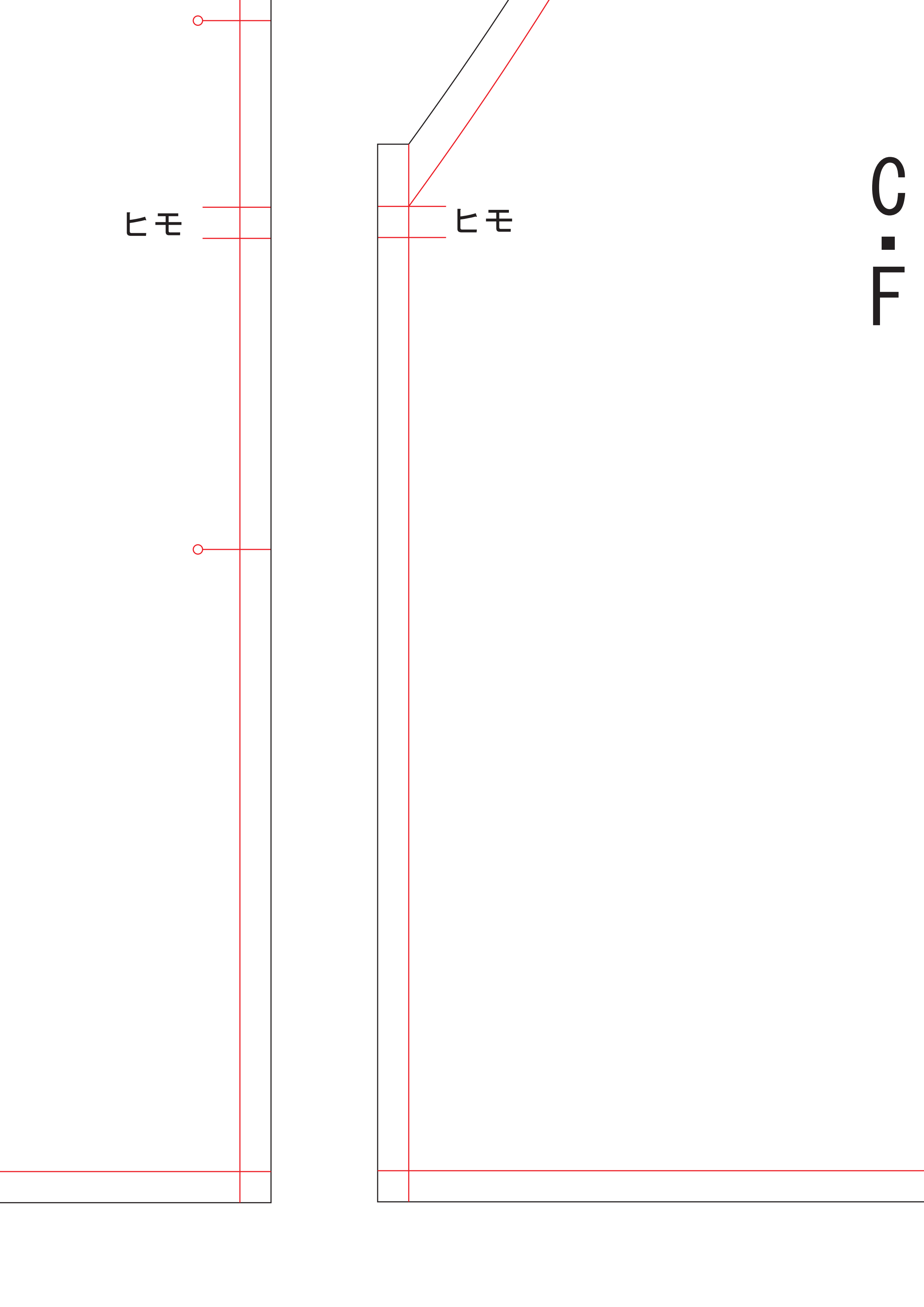

身ハツロ ○

ヒモ

スリット止 ○

丈75